



Instruction Manual

Cheddar Easy All-In-One Cheese Corn Shop

Export Model No. 2703-01-000





GOLD MEDAL® PRODUCTS CO.

10700 Medallion Drive, Cincinnati, Ohio 45241-4807 USA





SAFETY PRECAUTIONS

	⚠ DANGER
	<p>Machine must be properly grounded to prevent electrical shock to personnel. Failure to do so could result in serious injury, or death. DO NOT immerse any part of this equipment in water. DO NOT use excessive water when cleaning. Keep cord and plug off the ground and away from moisture. Always unplug the equipment before cleaning or servicing. Make sure all machine switches are in the OFF position before plugging the equipment into the receptacle.</p> <p>008_051514</p>

	⚠ DANGER
	<p>Improper installation, adjustment, alteration, service, or maintenance can cause property damage, injury, or death. Any alterations to this equipment will void the warranty and may cause a dangerous condition. This appliance is not intended to be operated by means of an external timer or separate remote-control system. NEVER make alterations to this equipment. Read the Installation, Operating, and Maintenance Instructions thoroughly before installing, servicing, or operating this equipment.</p> <p>014_020416</p>

	⚠ WARNING
	<p>To avoid burns, DO NOT touch heated surfaces. DO NOT place or leave objects in contact with heated surfaces.</p> <p>009_092414</p>



	⚠ WARNING
	<p>ALWAYS wear safety glasses when servicing this equipment.</p> <p>010_010914</p>



	⚠ WARNING
	<p>No user serviceable parts inside. Refer servicing to qualified service personnel.</p> <p>011_051514</p>

	⚠ WARNING
	<p>Read and understand operator's manual and all other safety instructions before using this equipment. To order copies of the operator's manual go to gmpopcorn.com or write to Gold Medal Products Co., 10700 Medallion Drive, Cincinnati, OH 45241 USA 1-(800)-543-0862</p> <p>022_060215</p>



SAFETY PRECAUTIONS (continued)

	 WARNING
	DO NOT allow direct contact of this equipment by the public when used in food service locations. Only personnel trained and experienced in the equipment operation may operate this equipment. Carefully read all instructions before operation. 012_010914

	 WARNING
	This machine is NOT to be operated by minors. 007_010914

This appliance is not intended for use by persons (including children) with reduced physical, sensory or mental capabilities, or lack of experience and knowledge, unless they have been given supervision or instruction concerning use of the appliance by a person responsible for their safety.

Note: Improvements are always being made to Gold Medal's equipment. This information may not be the latest available for your purposes. It is critical that you call Gold Medal's Technical Service Department at 1-800-543-0862 for any questions about your machine operations, replacement parts, or any service questions. (Gold Medal Products Co. does not assume any liability for injury due to careless handling and/or reckless operation of this equipment.) General images may be used in manual for reference only.

INSTALLATION INSTRUCTIONS

Inspection of Shipment

After unpacking, check thoroughly for any damage which may have occurred in transit. Claims should be filed immediately with the transportation company. The warranty does not cover damage that occurs in transit, or damage caused by abuse, or consequential damage due to the operation of this machine, since it is beyond our control (reference warranty in back of manual).

Manual

Read and understand the operator's manual and all other safety instructions before using this equipment. To order copies of the operator's manual go to gmpopcorn.com or write to Gold Medal Products Co., 10700 Medallion Drive, Cincinnati, OH 45241 USA 1-(800)-543-0862.

Model Description

2703-01-000: Export Cheddar Easy All-In-One Cheese Corn Shop, 8 gallon capacity.

This appliance is intended to be used in household and similar applications such as staff kitchen areas in shops, offices and other working environments; farm houses; by clients in hotels, motels, bed and breakfast or other residential type environments.

Items Included with this Unit



**4 Cup Glass Beaker
(Cheese Measure)**



Blade Scraper



Heat Lamp Bulb

Setup

This unit has been tested at the factory.

1. Remove all packaging and tape prior to operation.
2. Place unit on a sturdy, level base for use.
3. With the machine OFF and unplugged, install the heat lamp (reference image shown).
4. Place Blending Pot on rollers for use.
5. After setup, the unit should be cleaned prior to use (see Care and Cleaning section of this manual).

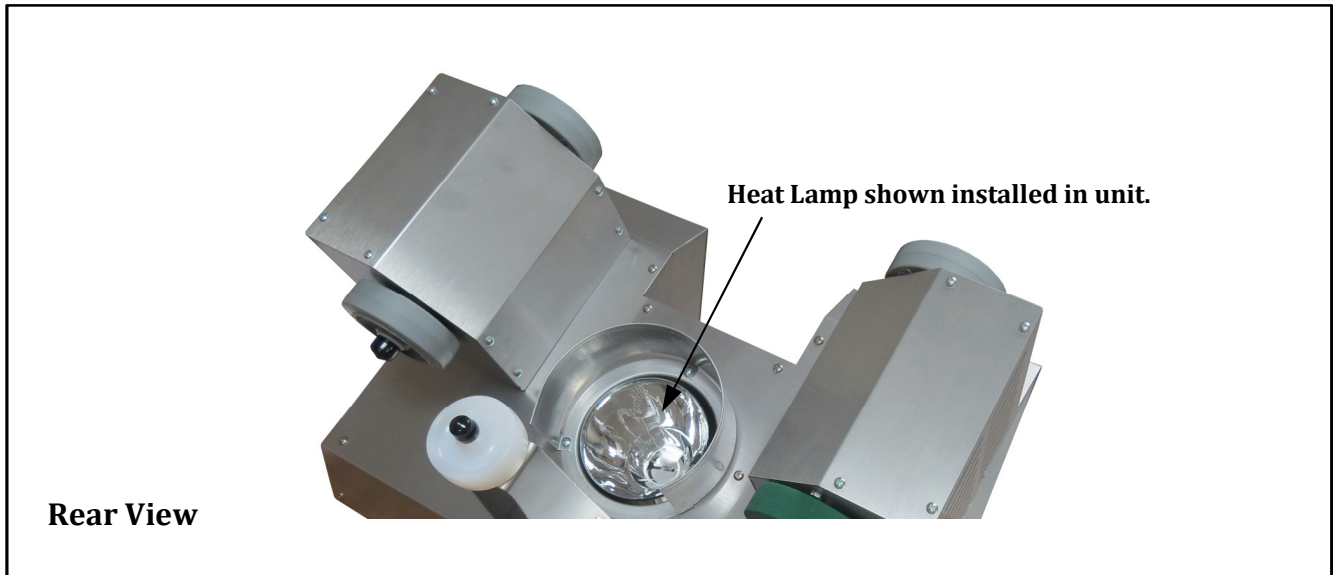





Electrical Requirements

The following power supply must be provided:

2703-01-000: 230 V~, 375 W, 50 Hz

	 DANGER
	<p>Machine must be properly grounded to prevent electrical shock to personnel. Failure to do so could result in serious injury, or death. DO NOT immerse any part of this equipment in water. DO NOT use excessive water when cleaning. Keep cord and plug off the ground and away from moisture. Always unplug the equipment before cleaning or servicing. Make sure all machine switches are in the OFF position before plugging the equipment into the receptacle.</p> <p>008_051514</p>

A certified electrician must furnish sufficient power for proper machine operation and install any supplied receptacle. We recommend this equipment be on a dedicated and protected circuit. Failure to wire properly will void the warranty and may result in damage to the machine. It is Gold Medal Products Co.'s recommendation that this machine be plugged directly into a wall outlet. The use of extension cords is not recommended due to safety concerns, and may cause sacrificed and/or reduced performance. Make sure cord is located to prevent a trip hazard or unit upset.

Before You Plug In Machine

1. Make sure all machine switches are in the OFF position before plugging the equipment into the receptacle.
2. Make sure the wall outlet can accept the grounded plugs (where applicable) on the power supply cord.
3. The wall outlet must have the proper polarity. If in doubt, have a competent electrician inspect the outlet and correct if necessary.
4. DO NOT use a grounded to un-grounded receptacle adapter (where applicable).
5. Install the unit in a level position.

	 CAUTION
	<p>If the supply cord is damaged, it must be replaced by Gold Medal Products Co., its service agent or similarly qualified persons in order to avoid a hazard.</p> <p>039_080614</p>

OPERATING INSTRUCTIONS

Controls and Their Functions

TUMBLER SWITCH

Two position, ON/OFF lighted rocker switch - supplies power to the tumbler drive motor. With this switch in the ON position, the blending pot will continually roll.

TUMBLER HEAT SWITCH

Two position, ON/OFF lighted rocker switch - turns the Heat Lamp ON/OFF.

WARMING PLATE HEAT CONTROL

Graduated dial from LO to HIGH which controls the warming plate heat.

INDICATOR LIGHT

When lit, this light indicates the warming plate is ON.

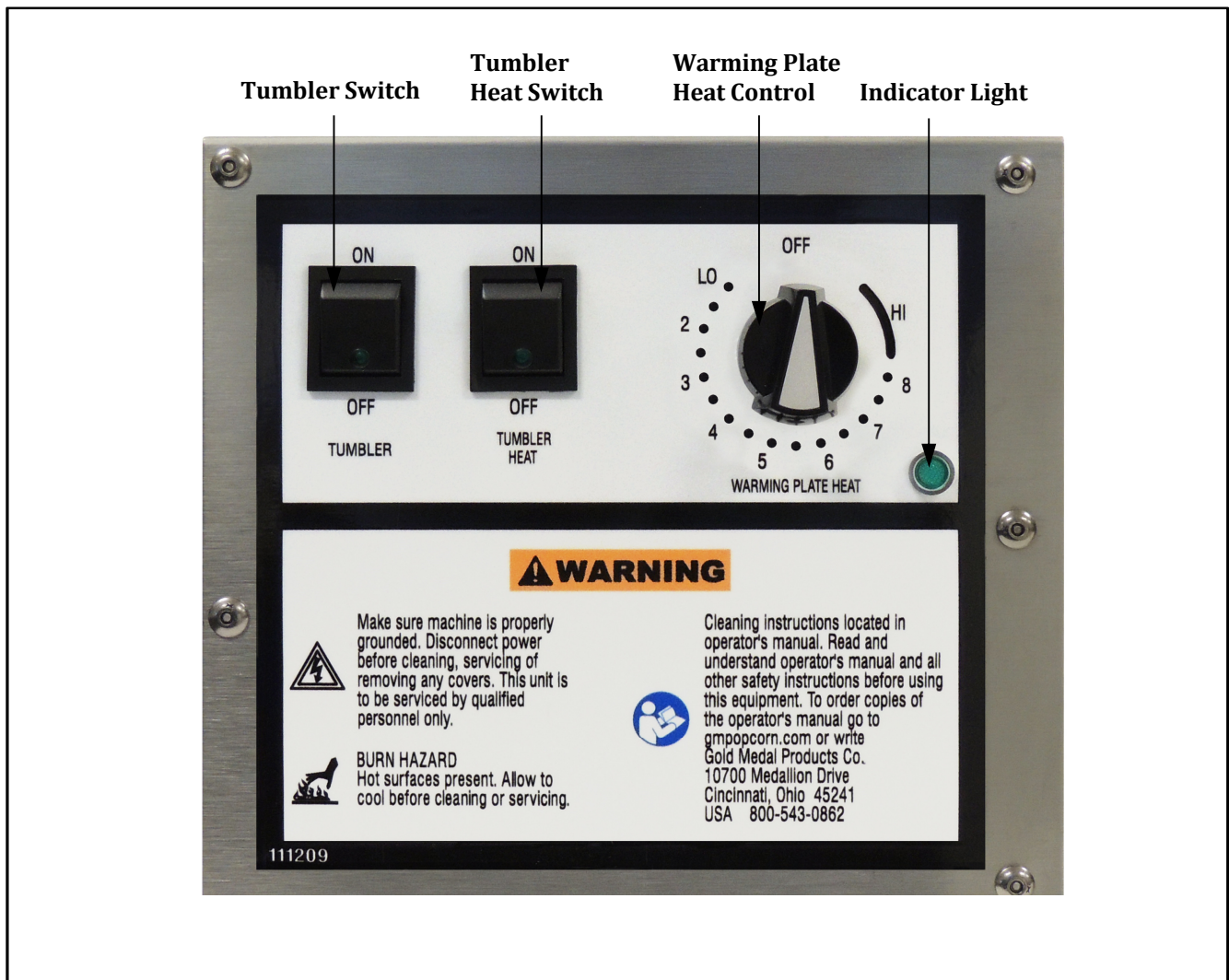



Operating Instructions

1. Place the Blending Pot on all the rollers securely (the Blending Pot has an 8 gallon capacity).
2. Fill the Cheese Measure with 3 cups of Gold Medal Products Co. Cheddar Pure Gold (Item No. 2327) and place on the warming plate.
3. Set the Warming Plate Heat Control on HIGH for approximately 20 minutes to warm the cheese. Stir occasionally for even heating, then reduce the temperature to prevent overheating.

CAUTION: Cheese Measure will be hot; DO NOT touch it with your hands. Use oven mitt or similar protective device when handling Cheese Measure.



The warming plate should be turned OFF when not in use.

4. Add product to be mixed to the Blending Pot.
5. Turn the Tumbler Switch ON and begin tumbling the product.
6. Turn the Tumbler Heat Switch ON to keep the product warm while tumbling.
7. For cheese corn, begin adding cheese mixture until the corn is coated as desired.
8. Turn the Tumbler Switch OFF.
9. Remove the Blending Pot and empty the contents.
10. Repeat the process for additional product.



Care and Cleaning

	 DANGER
	<p>Machine must be properly grounded to prevent electrical shock to personnel. DO NOT immerse in water. DO NOT clean appliance with a water jet. Always unplug the equipment before cleaning or servicing.</p> <p style="text-align: right;">025_111616</p>

	 WARNING
	<p>To avoid burns, DO NOT touch heated surfaces. DO NOT place or leave objects in contact with heated surfaces.</p> <p style="text-align: right;">009_092414</p>

Good sanitation practice demands that all food preparation equipment be cleaned regularly (only use non-toxic, food grade cleaners). A clean looking, well-kept machine is one of the best ways of advertising your product.

Follow the directions below to clean and sanitize the unit each day after use.

1. With the machine OFF, unplug the unit and allow it to cool before attempting to clean.
2. Make sure to clean all pans and accessories in order to sanitize them before each use.
3. Clean the outside of the unit with a soft cloth, dampened with soap and hot water.

Wipe the stainless steel parts with a clean cloth and cleaner designed for stainless steel, such as Gold Medal Watchdog Stainless Cleaner (Item No. 2088).

DO NOT use oven cleaners or abrasive materials as they will damage parts of the machine.



MAINTENANCE INSTRUCTIONS

	⚠ DANGER
	<p>Machine must be properly grounded to prevent electrical shock to personnel. Failure to do so could result in serious injury, or death. DO NOT immerse any part of this equipment in water. DO NOT use excessive water when cleaning. Keep cord and plug off the ground and away from moisture. Always unplug the equipment before cleaning or servicing. Make sure all machine switches are in the OFF position before plugging the equipment into the receptacle.</p> <p>008_051514</p>

	⚠ DANGER
	<p>Improper installation, adjustment, alteration, service, or maintenance can cause property damage, injury, or death. Any alterations to this equipment will void the warranty and may cause a dangerous condition. This appliance is not intended to be operated by means of an external timer or separate remote-control system. NEVER make alterations to this equipment. Read the Installation, Operating, and Maintenance Instructions thoroughly before installing, servicing, or operating this equipment.</p> <p>014_020416</p>

	⚠ WARNING
	<p>No user serviceable parts inside. Refer servicing to qualified service personnel.</p> <p>011_051514</p>

	⚠ CAUTION
	<p>THE FOLLOWING SECTIONS OF THIS MANUAL ARE INTENDED ONLY FOR QUALIFIED SERVICE PERSONNEL WHO ARE FAMILIAR WITH ELECTRICAL EQUIPMENT. THESE ARE NOT INTENDED FOR THE OPERATOR.</p> <p>027_010914</p>



ORDERING SPARE PARTS

1. Identify the needed part by checking it against the photos, illustrations, and/or parts list. (General images may be used in manual for reference only.)
2. Use only approved replacement parts when servicing this unit.
3. When ordering, please include part number, part name, and quantity needed.
4. Please include your model number, serial number, and date of manufacture (located on the machine nameplate/data plate) with your order.
5. Address all parts orders to:

Parts Department
Gold Medal Products Co.
10700 Medallion Drive
Cincinnati, Ohio 45241-4807

Or, place orders by phone or online:

Phone: (800) 543-0862
(513) 769-7676
Fax: (800) 542-1496
(513) 769-8500
E-mail: info@gmpopcorn.com
Web Page: gmpopcorn.com

Cabinet Exterior Front and Controls View

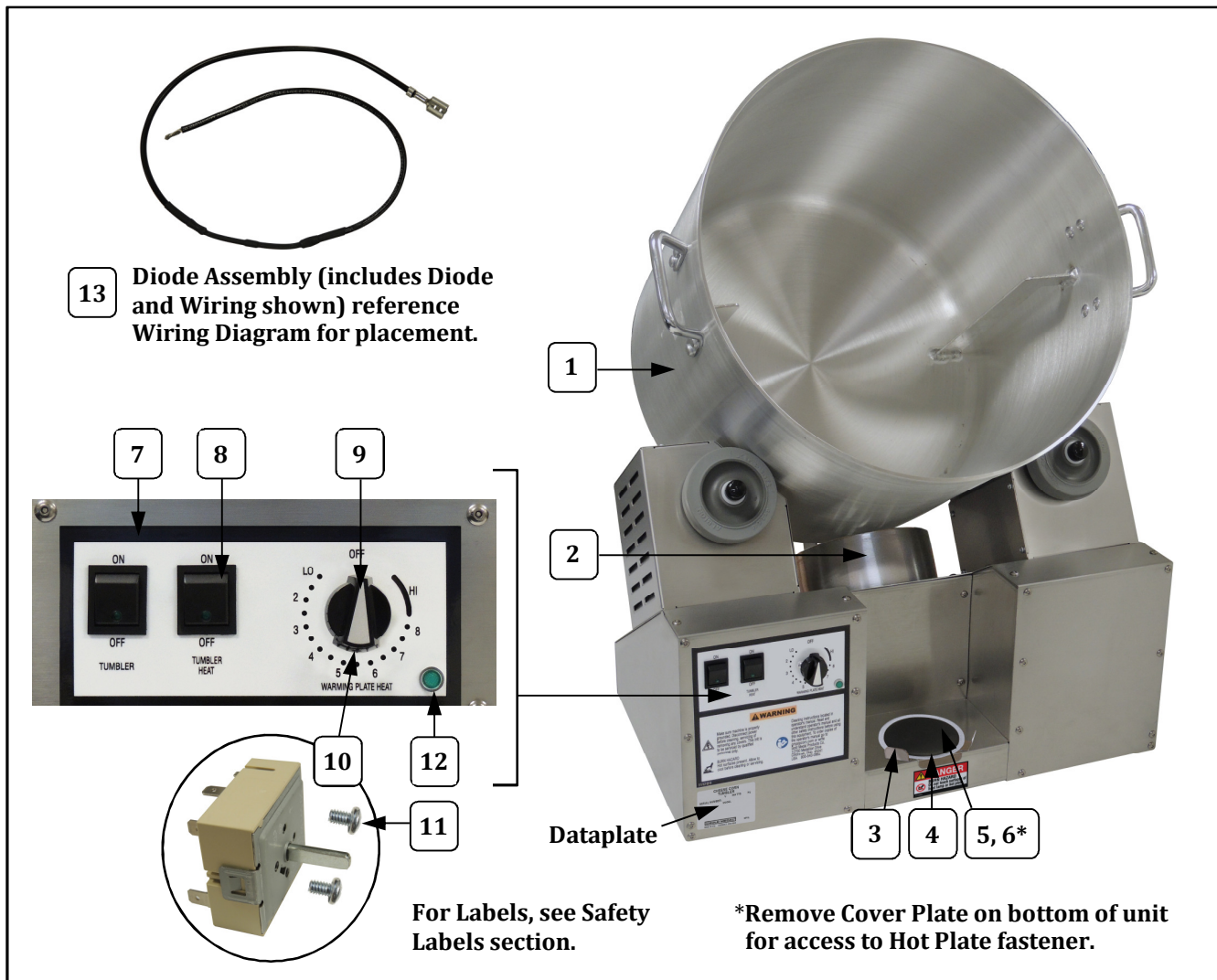

Item	Part Description	Part Number
		2703-01-000
1	BLENDING POT WELDMENT	17491
2	LIGHT SHIELD	111276
3	CUP SUPPORT	114049
4	TEFLON RING	111281
5	HOT PLATE 450W	111205EX
6*	M4 HEX NUT (fastener for hot plate)	111207
7	TUMBLER LABEL	111209
8	SWITCH, LIGHTED ROCKER GR	42798
9	CONTROL KNOB	38389
10	HEAT CONTROL	87301
11	8-32 X 1/4 PHIL PAN M/S	87314
12	PILOT LIGHT, GREEN	48660EX
13	DIODE ASSEMBLY	111283

Cabinet Rear and Bottom View – Parts Breakdown

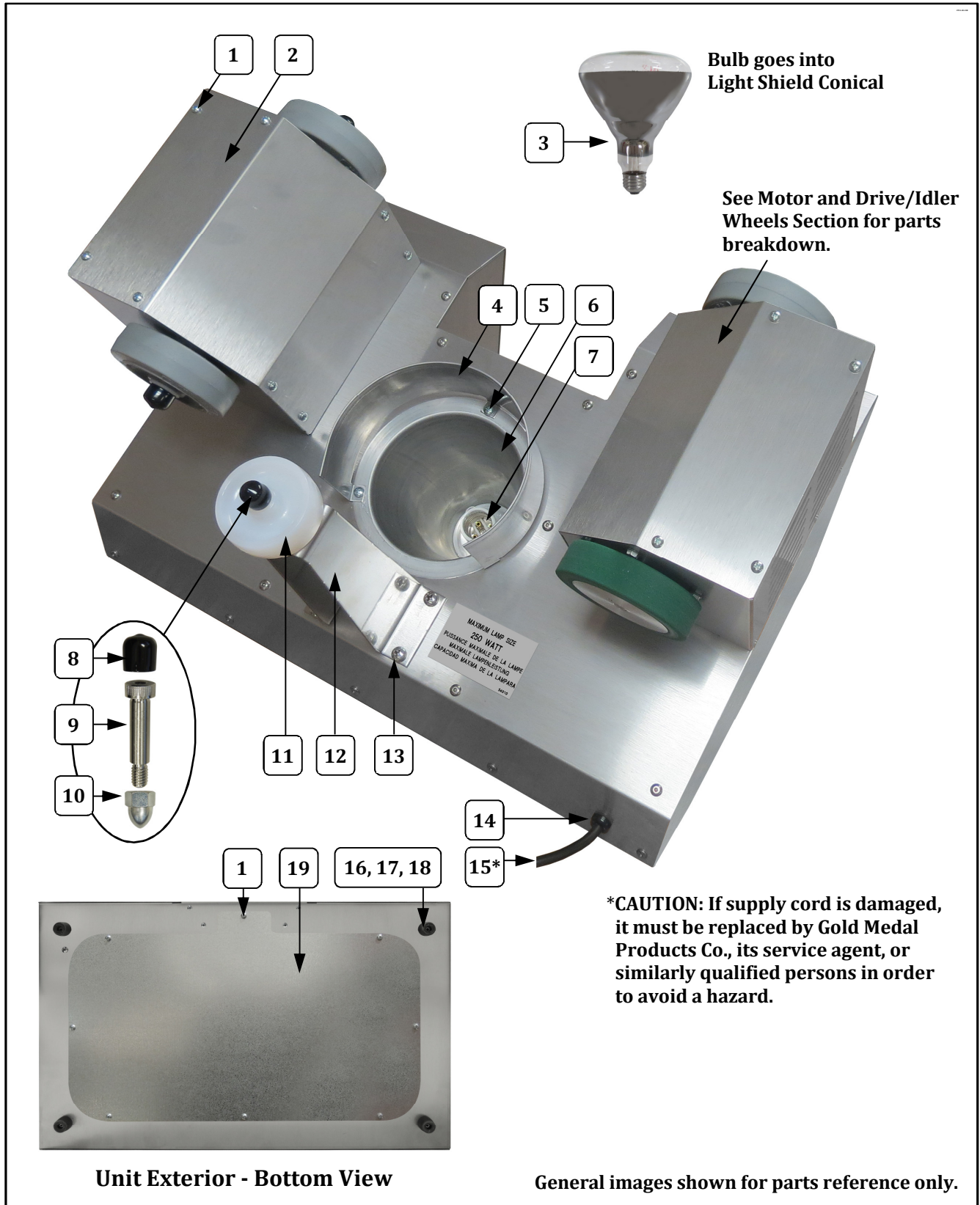



Cabinet Rear and Bottom View – Parts List

Item	Part Description	Part Number
		2703-01-000
1	SCREW #8-32X3/8 PAN HD PH	74141
2	COVER PLATE	111203
3	HEAT LAMP 250W, 220/230V	47138
4	LIGHT SHIELD	111276
5	10-24 X 3/8 PAN HD PH T23	38111
6	LIGHT SHIELD, CONICAL	53077
7	LAMP HOLDER	47047
8	CAP	17784
9	3/8 X 1-1/4 SHOULDER BOLT	17503
10	ACORN NUT 5/16-18	77610
11	NYLON WHEEL	17504
12	IDLER BRACKET	111240
13	1/4-20 X 1/2 P/H PHIL	12471
14	STRAIN RELIEF#SR-6N-4	87810
15*	EXPORT POWER SUPPLY CORD	42369
16	RUBBER FEET 3/4IN HIGH	47155
17	8-32 X 1 PH PAN M/S S.S.	12219
18	8-32 SERRATED FLANGE NUT	61151
19	COVER (bottom cover for access to controls interior)	111479

Motor and Drive/Idler Wheels

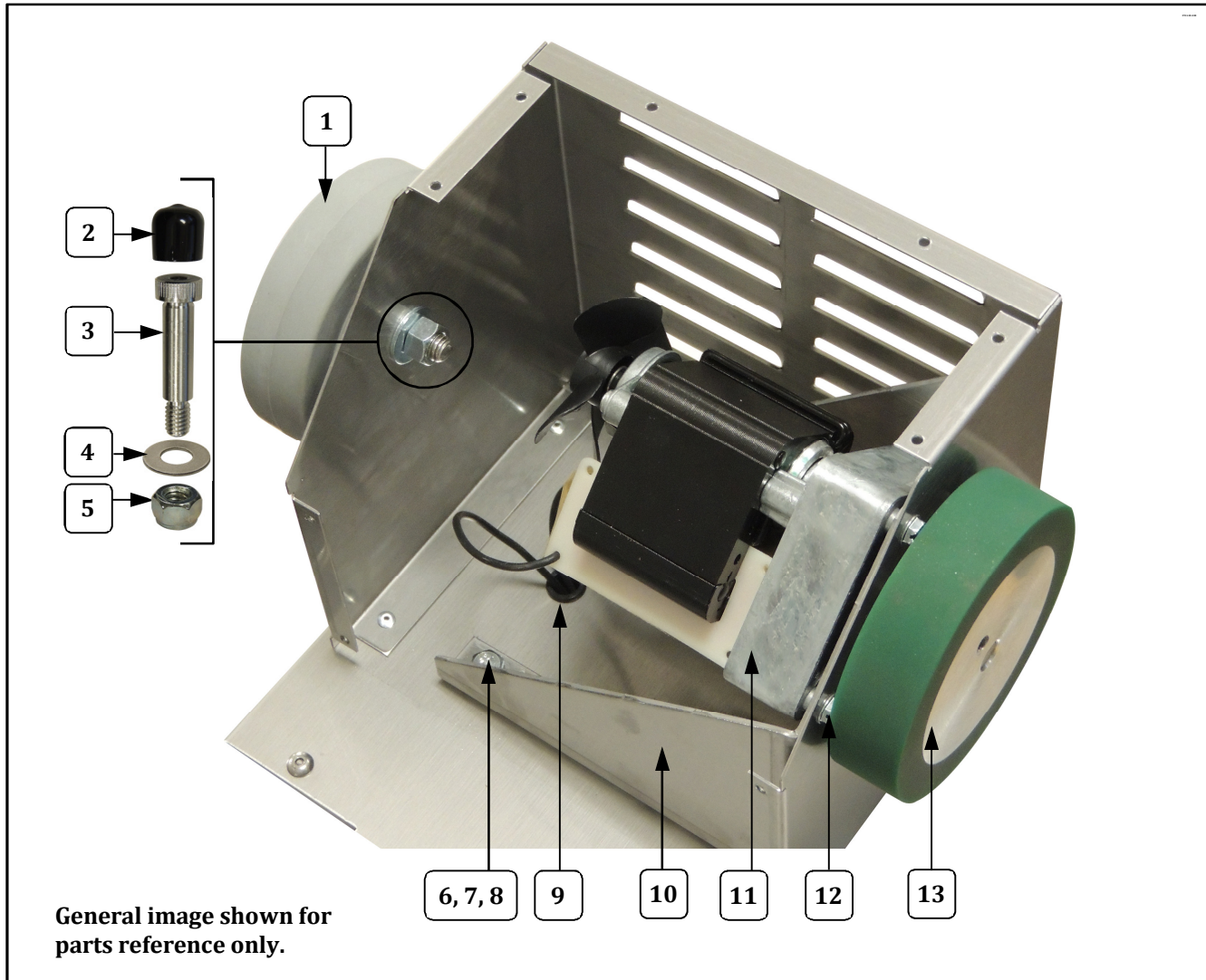

Item	Part Description	Part Number
		2703-01-000
1	IDLER WHEEL	17506
2	CAP	111230
3	1/2"X1-1/2" SHOULDER BOLT	111210
4	3/8" FLAT WASHER, ZINC	111231
5	3/8-16 NYLON LOCKNUT	114032
6	1/4-20X3/4 LG HEX HD BOLT	13164
7	1/4 FLAT WASHER ST. STL	42989
8	HEX NUT 1/4-20 ESLOK	42361
9	BUSHING, SNAP .500 IN	47236
10	MOTOR MOUNT BRACKET	111200
11	DRIVE MOTOR	17651EX
12	10-32 X 1 UNSL NON-IND	49376
13	DRIVE WHEEL (includes Set Screw)	111202

Safety Labels

Unit Labels

Power Cord Label

Item	Part Description	Part Number
		2703-01-000
1	TUMBLER LABEL	111209
2	BURN HAZARD LABEL	111282
3	WARNING, MAX LAMP 250W	54010
4	MAIN GROUND LABEL	42375
5	WARNING LABEL CORD	68720

Accessories

Item	Part Description	Part Number
		2703-01-000
1	4 CUP GLASS BEAKER W/HAND	111355
2	9-1/2" FLAT BLADE SCRAPER	111244



Wiring Diagram

Model No. 2703-01-000

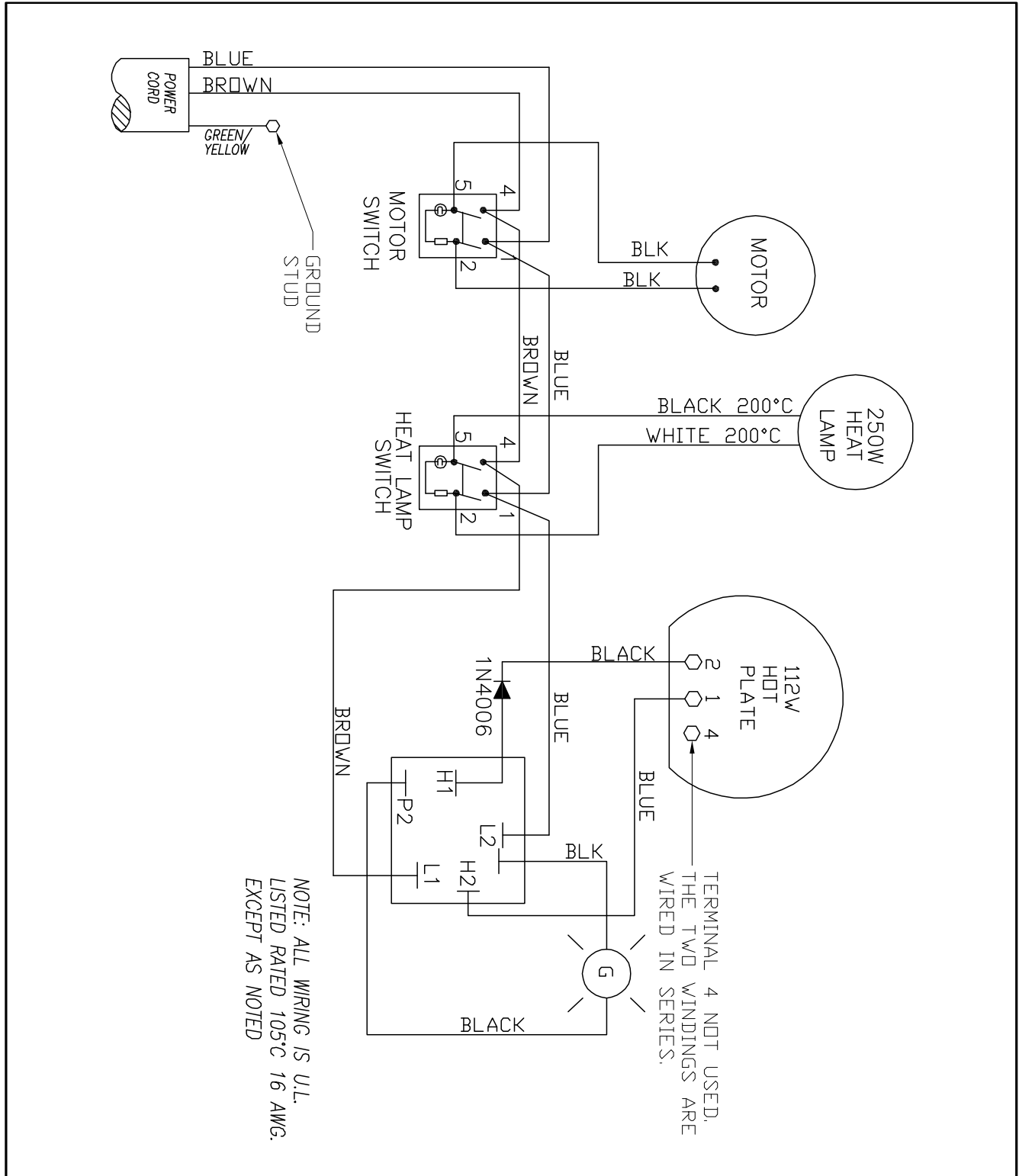



WARRANTY

Gold Medal Products Co. warrants to the original purchaser each item of its manufacture to be free of defects in workmanship and material under normal use and service. Gold Medal Products Co.'s obligation under this warranty is limited solely to repairing or replacing parts, f.o.b. Cincinnati, Ohio, which in its judgment are defective in workmanship or material and which are returned, freight prepaid, to its Cincinnati, Ohio factory or other designated point. Except for "Perishable Parts" on specific machines, the above warranty applies for a period of two (2) years from the date of original sale to the original purchaser of equipment when recommended operating instructions and maintenance procedures have been followed. These are packed with the machine. Parts warranty is two (2) years, labor is six (6) months.

THIS WARRANTY IS IN LIEU OF ALL OTHER WARRANTIES EXPRESSED OR IMPLIED, AND OF ALL OTHER OBLIGATIONS OR LIABILITIES ON OUR PART, INCLUDING THE IMPLIED WARRANTY OF MERCHANTABILITY. THERE ARE NO WARRANTIES WHICH EXTEND BEYOND THE DESCRIPTION ON THE FACE HEREOF. In no event shall Gold Medal Products Co. be liable for special, incidental or consequential damages. No claim under this warranty will be honored if the equipment covered has been misused, neglected, damaged in transit, or has been tampered with or changed in any way. No claim under this warranty shall be honored in the event that components in the unit at the time of the claim were not supplied or approved by Gold Medal Products Co. This warranty is effective only when electrical items have been properly attached to city utility lines only at proper voltages. This warranty is not transferable without the written consent of Gold Medal Products Co.

The term "Original Purchaser" as used in this warranty shall be deemed to mean that person, firm, association, or corporation who was billed by the GOLD MEDAL PRODUCTS CO., or their authorized distributor for the equipment.

THIS WARRANTY HAS NO EFFECT AND IS VOID UNLESS THE ORIGINAL PURCHASER FIRST CALLS GOLD MEDAL PRODUCTS CO. AT 1-800-543-0862 TO DISCUSS WITH OUR SERVICE REPRESENTATIVE THE EQUIPMENT PROBLEM, AND, IF NECESSARY, FOR INSTRUCTIONS CONCERNING THE REPAIR OR REPLACEMENT OF PARTS.

NOTE: This equipment is manufactured and sold for commercial use only.



GOLD MEDAL[®] PRODUCTS CO.

10700 Medallion Drive, Cincinnati, Ohio 45241-4807 USA

gmpopcorn.com

Phone: (800) 543-0862 Fax: (800) 542-1496
(513) 769-7676 (513) 769-8500