



Instruction Manual

Titan 6 oz. Popper

Export Model No. 2551EX



GOLD MEDAL[®] PRODUCTS CO.

10700 Medallion Drive, Cincinnati, Ohio 45241-4807 USA







Table of Contents



SAFETY PRECAUTIONS	3
INSTALLATION INSTRUCTIONS	5
Inspection of Shipment	5
Manual	5
Items Included with this Unit	5
Setup	6
Electrical Requirements	7
Before You Plug In Machine	7
OPERATING INSTRUCTIONS	8
Controls and Their Functions	8
Popping Corn Instructions	9
Care and Cleaning	10
Troubleshooting	12
AGITATOR SET COLLAR ADJUSTMENT	13
MAINTENANCE INSTRUCTIONS	14
ORDERING SPARE PARTS	15
Replacing Broken Glass	16
6 oz. Kettle Assembly (49434EXN) – Agitator Assembly View	17
6 oz. Kettle Assembly (49434EXN) – Kettle Bottom Assembly	18
Cabinet Exterior – Front View	19
Door Hardware Kits – Individual Component Breakdown	20
Cabinet Interior – Controls View	21
Cabinet Bottom – Corn Pan Element View	22
Safety Labels	23
Accessories	23
Wiring Diagram	24
WARRANTY	25





SAFETY PRECAUTIONS

	 DANGER
	<p>Machine must be properly grounded to prevent electrical shock to personnel. Failure to do so could result in serious injury, or death. DO NOT immerse any part of this equipment in water. DO NOT use excessive water when cleaning. Keep cord and plug off the ground and away from moisture. Always unplug the equipment before cleaning or servicing. Make sure all machine switches are in the OFF position before plugging the equipment into the receptacle.</p> <p style="text-align: right;">008_051514</p>

	 DANGER
	<p>Improper installation, adjustment, alteration, service, or maintenance can cause property damage, injury, or death. Any alterations to this equipment will void the warranty and may cause a dangerous condition. This appliance is not intended to be operated by means of an external timer or separate remote-control system. NEVER make alterations to this equipment. Read the Installation, Operating, and Maintenance Instructions thoroughly before installing, servicing, or operating this equipment.</p> <p style="text-align: right;">014_020416</p>



	 WARNING
	<p>To avoid burns, DO NOT touch the kettle or any heated surface. DO NOT place or leave objects in contact with heated surfaces.</p> <p style="text-align: right;">013_092414</p>



	 WARNING
	<p>ALWAYS wear safety glasses when servicing this equipment.</p> <p style="text-align: right;">010_010914</p>

	 WARNING
	<p>No user serviceable parts inside. Refer servicing to qualified service personnel.</p> <p style="text-align: right;">011_051514</p>

	 WARNING
	<p>Read and understand operator's manual and all other safety instructions before using this equipment. To order copies of the operator's manual go to gmpopcorn.com or write to Gold Medal Products Co., 10700 Medallion Drive, Cincinnati, OH 45241 USA 1-(800)-543-0862</p> <p style="text-align: right;">022_060215</p>



	 WARNING
	DO NOT allow direct contact of this equipment by the public when used in food service locations. Only personnel trained and experienced in the equipment operation may operate this equipment. Carefully read all instructions before operation. <small>012_010914</small>

	 WARNING
	This machine is NOT to be operated by minors. <small>007_010914</small>

This appliance is not intended for use by persons (including children) with reduced physical, sensory or mental capabilities, or lack of experience and knowledge, unless they have been given supervision or instruction concerning use of the appliance by a person responsible for their safety.

Note: Improvements are always being made to Gold Medal's equipment. This information may not be the latest available for your purposes. It is critical that you call Gold Medal's Technical Service Department at 1-800-543-0862 for any questions about your machine operations, replacement parts, or any service questions. (Gold Medal Products Co. does not assume any liability for injury due to careless handling and/or reckless operation of this equipment.) General images may be used in manual for reference only.



INSTALLATION INSTRUCTIONS

Inspection of Shipment

After unpacking, check thoroughly for any damage which may have occurred in transit. Claims should be filed immediately with the transportation company. The warranty does not cover damage that occurs in transit, or damage caused by abuse, or consequential damage due to the operation of this machine, since it is beyond our control (reference warranty in back of manual).

Manual

Read and understand the operator's manual and all other safety instructions before using this equipment. To order copies of the operator's manual go to gmpopcorn.com or write to Gold Medal Products Co., 10700 Medallion Drive, Cincinnati, OH 45241 USA 1-(800)-543-0862.

Items Included with this Unit

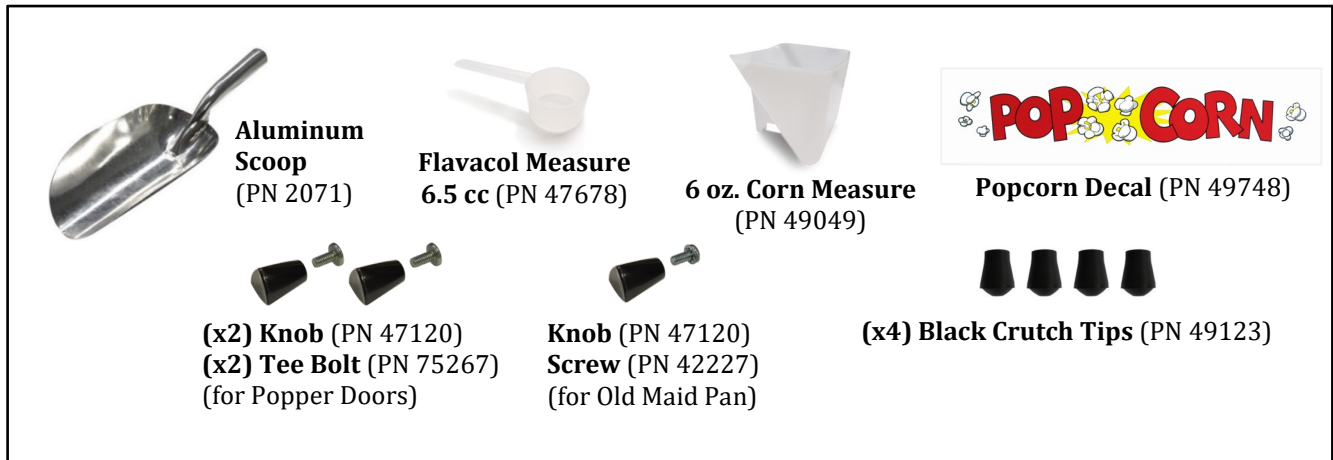



Setup

This unit has been tested at the factory.

1. Remove all packaging and tape prior to operation. Remove accessories and carefully remove kettle packed in cabinet interior.
2. Place unit on a sturdy, level base.
3. Unit has 4 glide feet preinstalled at the factory (see image below). Install a Black Crutch Tip on each foot. Firmly push crutch tip over glide until it covers glide entirely.
4. Tilt kettle and insert into hanger arms, then allow kettle to return naturally to an upright position (see image below).
5. Plug kettle lead into receptacle located on ceiling of cabinet interior. Align keyed or hook shaped prong with the correct opening, then push plug all the way in and twist or rotate to lock in place. To unplug, untwist kettle plug before attempting to pull from receptacle.
6. Door knobs are shipped in accessories pack. Install a door knob with tee bolt on each popper door; install knob with screw on old maid pan.
7. Apply Popcorn decal to unit.
8. After setup, unit should be cleaned prior to use (see Care and Cleaning section).

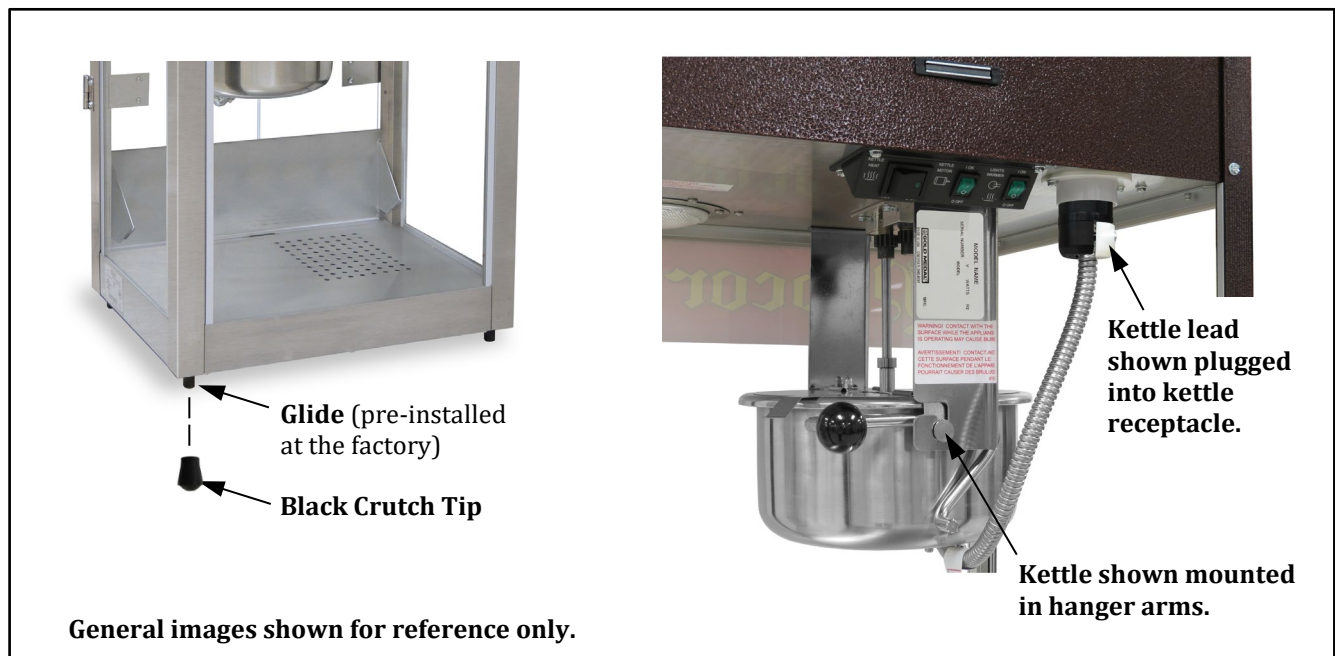





Electrical Requirements

The following power supply must be provided (reference unit Data Plate for Wattage requirement):

220-230 V~, 50/60 Hz



Potential Electrical Variations: 220 V~, 60 Hz

	 DANGER
	<p>Machine must be properly grounded to prevent electrical shock to personnel. Failure to do so could result in serious injury, or death. DO NOT immerse any part of this equipment in water. DO NOT use excessive water when cleaning. Keep cord and plug off the ground and away from moisture. Always unplug the equipment before cleaning or servicing. Make sure all machine switches are in the OFF position before plugging the equipment into the receptacle.</p> <p style="text-align: right; font-size: small;">008_051514</p>

A certified electrician must furnish sufficient power for proper machine operation and install any supplied receptacle (reference unit Data Plate for model specific Volts AC, Hertz, and Wattage requirements). We recommend this equipment be on a dedicated and protected circuit. Failure to wire properly will void the warranty and may result in damage to the machine. It is Gold Medal Products Co.'s recommendation that this machine be plugged directly into a wall outlet. The use of extension cords is not recommended due to safety concerns, and may cause sacrificed and/or reduced performance. Make sure cord is located to prevent a trip hazard or unit upset. Units with an IEC Power Cord - make sure the IEC cord is properly seated into the IEC receptacle before powering up the machine.

Before You Plug In Machine

1. Make sure all machine switches are OFF before plugging equipment into receptacle.
2. Make sure wall outlet can accept the grounded plugs (where applicable) on the power supply cord.
3. The wall outlet must have the proper polarity. If in doubt, have a competent electrician inspect the outlet and correct if necessary.
4. **DO NOT** use a grounded to un-grounded receptacle adapter (where applicable).
5. Install unit in a level position.

	 CAUTION
	<p>If the supply cord is damaged, it must be replaced by Gold Medal Products Co., its service agent or similarly qualified persons in order to avoid a hazard.</p> <p style="text-align: right; font-size: small;">039_080614</p>



OPERATING INSTRUCTIONS

Controls and Their Functions

KETTLE HEAT SWITCH

ON/OFF lighted rocker switch - supplies power to the heating elements in the popping kettle. The green switch light ON indicates there is power to the kettle heating element.

KETTLE MOTOR SWITCH

ON/OFF lighted rocker switch - supplies power to the kettle agitator motor. The Kettle Motor Switch **MUST** be ON at all times when there is popcorn (popped or un-popped) in the kettle. The green switch light ON indicates there is power to the agitator motor.

LIGHTS/WARMER SWITCH

ON/OFF lighted rocker switch - supplies power to the interior cabinet light, and heat element for the corn pan.

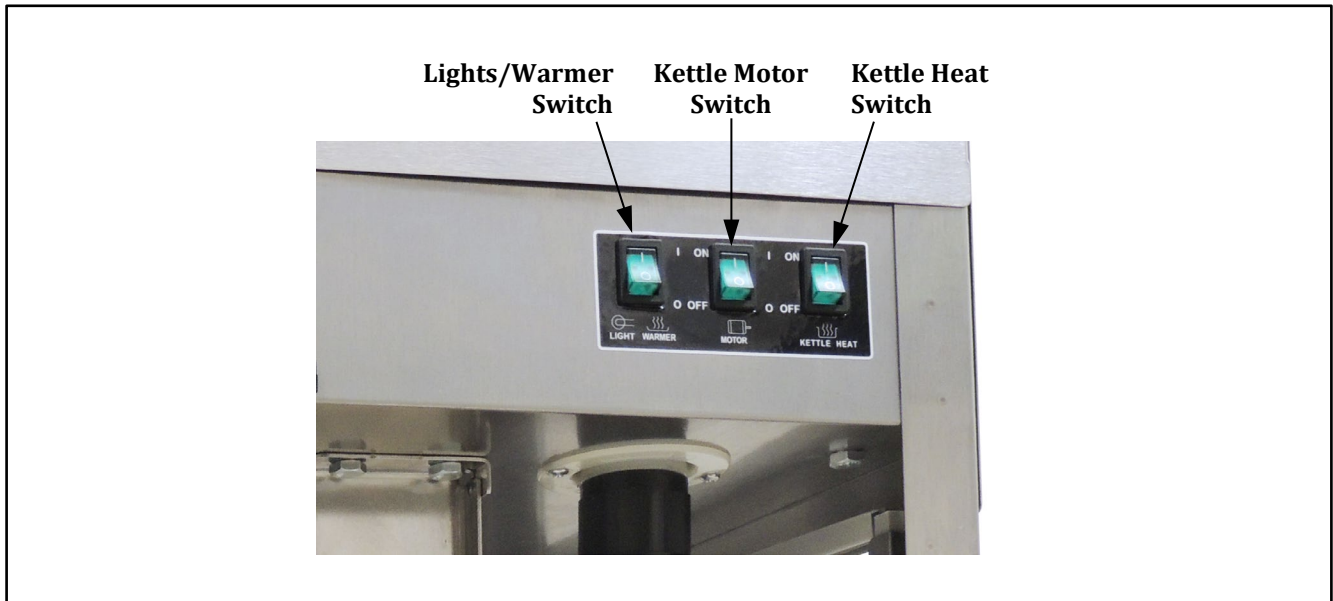



Popping Corn Instructions

This section describes instructions for popping Standard (salted) popcorn, and for popping Pappy's Kettle Corn.

Amount of Popcorn and Oil

The popper is equipped with a corn, salt, and oil measure. We recommend flavored and colored coconut oil. Popcorn popped in coconut oil stays fresh longer and does not leave black deposits in the kettle like other oils. Use only top quality, fresh popcorn from reputable suppliers.

Kettle Size	Popcorn Charge	Oil Charge	Flavacol (Salt)
6 oz.	6 oz. (177 ml)	2 oz. (59 ml)	1/2 Tblsp. (7.5cc) use small scoop provided

Premeasure all ingredients (adjust as needed for desired taste), or for best results use Mega-Pop® premeasured popcorn and oil pouch made for your kettle size.

1. Turn all switches ON.
2. To determine when kettle is ready to pop corn (about 4 minutes), test pop three kernels of corn in one ounce (30 ml) of popping oil. When kernels pop, kettle is ready.
3. Lift kettle lid, pour in popcorn and Flavacol, then add oil; close lid.
4. When corn has finished popping, gently dump the popcorn.

Popping Tip: On final batch, turn Kettle Heat Switch OFF just as lids are forced open by the popping corn (kettle has plenty of heat to finish popping). This helps eliminate smoke/odor from any oil residue remaining in kettle.

5. When finished popping, turn KETTLE HEAT and KETTLE MOTOR switches OFF.
NEVER LEAVE THE HEAT ON WHEN YOU ARE NOT POPPING CORN!



Care and Cleaning

	⚠ DANGER
	Machine must be properly grounded to prevent electrical shock to personnel. DO NOT immerse in water. DO NOT clean appliance with a water jet. Always unplug the equipment before cleaning or servicing. 025_111616

	⚠ WARNING
	To avoid serious burns, DO NOT touch the kettle while it is hot! 028_082715

Good sanitation practice demands that all food preparation equipment be cleaned regularly (only use non-toxic, food grade cleaners). A clean looking, well-kept machine is one of the best ways of advertising your product.

For surfaces needing further cleaning or degreasing, Watchdog Stainless Cleaner (Item No. 2088) or Watchdog Concession Equipment Degreaser (Item No. 2580) is available for use accordingly. For any cleaning products used, follow the manufacturer's instructions on the product. **DO NOT use oven cleaners or abrasive materials** as they will damage parts of machine.

Note: It is extremely important to follow all cleaning procedures, otherwise parts damage and equipment failure will result. The warranty does not cover parts that are damaged due to improper cleaning.

Daily Kettle Cleaning Instructions

1. Turn the power switch OFF and unplug the unit.

CAUTION: A hot kettle will cause burns if you touch it. Allow kettle to cool at least 1 hour before attempting to clean. DO NOT use ice or water to cool down a hot kettle! Severe kettle damage will result and steam burns may occur!

2. When cool, wipe **outside** of kettle clean using a clean, soft cloth and Gold Medal Watchdog Stainless Cleaner (Item No. 2088). **DO NOT** use oven cleaners or abrasive materials as they will damage the kettle.
3. Mix 2 tablespoons (29.6 ml) of Gold Medal's Heat'n Kleen (Item No. 2095) in 1 gallon (3.8 L) of water.
4. Only pour enough of the Heat'n Kleen pre-mixed solution into the kettle to fill it 1/2 inch (12.7 mm) deep (it is not necessary to use the entire gallon at once).
5. Plug in the unit.
6. Turn kettle heat ON. When solution starts to boil, turn kettle heat OFF.
7. Allow kettle to cool at least 1 hour, then unplug unit.



8. Dump solution into a bucket, do not spill any in the interior of machine.
9. Rinse kettle interior with clean water and a clean cloth.
10. Dump any water remaining into a bucket (do not spill any in the interior of machine), then wipe the kettle interior clean with a clean dry cloth.
For an extra dirty kettle, the process may be repeated; or, after turning kettle heat OFF, allow solution to sit in kettle overnight. The next morning, finish the cleaning steps.
11. With unit OFF and unplugged, use a clean SLIGHTLY damp cloth (wring ANY EXCESS water from cloth before use) and wipe the kettle lead cord clean. **DO NOT get moisture into the kettle lead-in cord, severe damage will result.**
12. After kettle cleaning, check to be sure the crossbar fasteners are securely tightened.

Daily Unit Cleaning Instructions

1. Turn machine OFF, unplug unit and allow it to cool before attempting to clean.
2. Remove any remaining popcorn.
3. Remove all pans/accessories and take them to the sink to clean with soap and water, then rinse and dry.
4. Wipe the unit clean using a clean, SLIGHTLY damp cloth to remove any grease from the glass and cabinet (cloth may be SLIGHTLY dampened with soap and water, then wipe again with clean water to remove any remaining cleaner).
5. Clean glass panels with glass cleaner. Gold Medal Watchdog Glass Cleaner (Item No. 2588) is recommended.
Ammonia cleaners will damage plastic doors/panels. Only use a non-ammonia cleaner, such as Gold Medal Watchdog Glass Cleaner (Item No. 2588).
6. Reinstall the clean, dry pans/accessories.
7. Check the kettle lead cord, make sure it is fully plugged into the kettle receptacle and the plug (or plug collar) is fully twisted to lock it into place.



Troubleshooting

Issue	Possible Cause	Solution
No Power to the Unit	A. No Power to the Unit	A. Make sure the unit's power cord is plugged in.
Kettle Does Not Heat	A. Power to the Kettle B. Kettle Heat Switch C. Heating Element	A. Make sure kettle lead-in cord is plugged in and twisted to lock into the kettle receptacle. B. Have a qualified service person check the voltage to and from the Kettle Heat Switch; if switch is defective, replace it. C. Heating element in the kettle may be burned out. Check with a qualified service person for inspection/repair.
Long Popping Cycles (Longer than 4 minutes for Salt Popcorn)	A. Low Voltage B. Inadequate Supply Lines C. Inferior Corn	A. If the machine is operated on low voltage, this could cause the kettle not to reach the proper operating temperature. Check with a qualified electrician. B. Inadequately sized electrical supply lines or use of extension cord, in addition to being a fire hazard, would also prevent the kettle from reaching the proper operating temperature. Check with a qualified electrician. C. Inferior quality corn would result in longer popping cycles. Use only top quality hybrid popcorn from reputable suppliers. Even then, if you let your corn pick up moisture or dry out, your popping cycles will be slow.
Kettle Agitator Shaft not Rotating If the kettle agitator shaft is not rotating, DO NOT pop corn.	A. Kettle Motor Switch B. Kettle Agitator Shaft/Stir Blade not rotating. (Unit must be OFF, unplugged and cool prior to checking or adjusting the agitator assembly.)	A. Make sure the Kettle Motor Switch is ON. If the switch is ON, and the shaft is not rotating, the switch or motor may be faulty, contact qualified service personnel for inspection/repair. B. Kettles with a FLOATING Stir Rod – lift the agitator weight and check the clearance between the shaft and the kettle bottom; it should be a minimum of 1/32" (1 mm) (thickness of a dime). To make shaft adjustments, reference the Agitator Set Collar Adjustment section.



Agitator Set Collar Adjustment

The following instructions describe how to properly adjust set collars on an agitator assembly with a floating stir rod.

Steps to Adjust Set Collars

Step 1: Turn machine OFF, unplug unit, and allow it to cool completely before attempting to adjust the agitator height.

Step 2: Loosen the set screw in each set collar to be adjusted.

Step 3: With the kettle mounted in the popper, adjust the shaft so the Spur Gears are halfway engaged, and the Needle Bearing is at least halfway engaged in the gear block (reference image at right).

DO NOT set spur gears at full gear contact; it can cause binding as the kettle is dumped.

Step 4: Snug tighten only, the set screw in set collar above the crossbar to hold position. Then, lift the agitator weight and check the clearance between the shaft and the kettle bottom. If there is adequate clearance, fully tighten the set screw to secure set collar in place.

Step 5: Adjust clearance between the bottom of the crossbar and the lower set collar to $1/32''$ (1 mm) (thickness of a dime); then re-tighten set screw to secure in place (reference image).

Step 6: Adjust set collar for agitator weight to be between $3/16''$ to $1/4''$ (4.8 to 6.4 mm) above the agitator weight. Once adjusted, re-tighten set screw to secure in place.

Agitator shown for general image reference only (lids not shown for clarity).

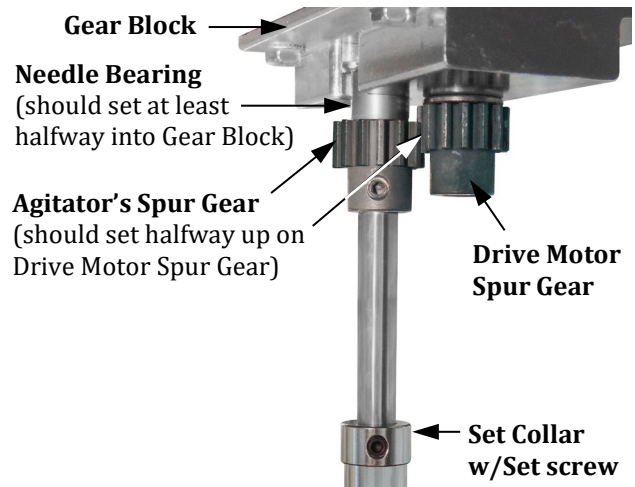



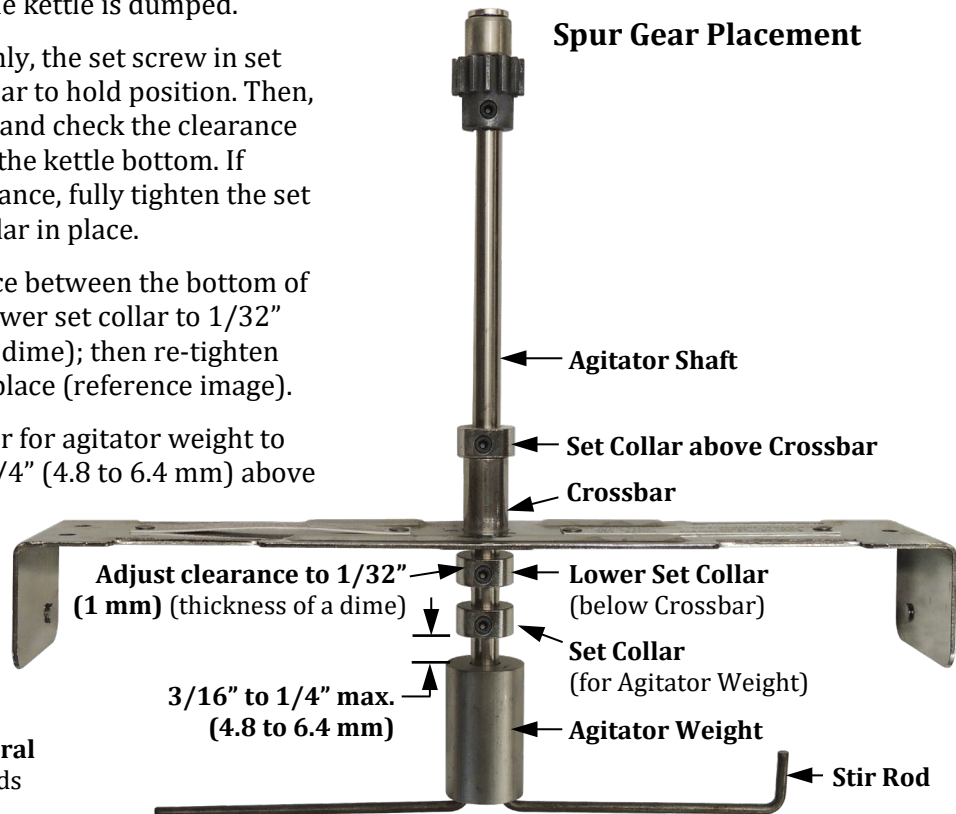

Spur Gear Placement







MAINTENANCE INSTRUCTIONS

	 DANGER
	<p>Machine must be properly grounded to prevent electrical shock to personnel. Failure to do so could result in serious injury, or death. DO NOT immerse any part of this equipment in water. DO NOT use excessive water when cleaning. Keep cord and plug off the ground and away from moisture. Always unplug the equipment before cleaning or servicing. Make sure all machine switches are in the OFF position before plugging the equipment into the receptacle.</p> <p style="text-align: right; font-size: small;">008_051514</p>

	 DANGER
	<p>Improper installation, adjustment, alteration, service, or maintenance can cause property damage, injury, or death. Any alterations to this equipment will void the warranty and may cause a dangerous condition. This appliance is not intended to be operated by means of an external timer or separate remote-control system. NEVER make alterations to this equipment. Read the Installation, Operating, and Maintenance Instructions thoroughly before installing, servicing, or operating this equipment.</p> <p style="text-align: right; font-size: small;">014_020416</p>

	 WARNING
	<p>No user serviceable parts inside. Refer servicing to qualified service personnel.</p> <p style="text-align: right; font-size: small;">011_051514</p>

	 CAUTION
	<p>THE FOLLOWING SECTIONS OF THIS MANUAL ARE INTENDED ONLY FOR QUALIFIED SERVICE PERSONNEL WHO ARE FAMILIAR WITH ELECTRICAL EQUIPMENT. THESE ARE NOT INTENDED FOR THE OPERATOR.</p> <p style="text-align: right; font-size: small;">027_010914</p>



ORDERING SPARE PARTS

1. Identify the needed part by checking it against the photos, illustrations, and/or parts list. (General images may be used in manual for reference only.)
2. Use only approved replacement parts when servicing this unit.
3. When ordering, please include part number, part name, and quantity needed.
4. Please include your model number, serial number, and date of manufacture (located on the machine nameplate/data plate) with your order.
5. Address all parts orders to Parts Department, Gold Medal Products Co., 10700 Medallion Drive, Cincinnati, Ohio 45241-4807

or place orders by phone or online:

Phone: (800) 543-0862
(513) 769-7676

Fax: (800) 542-1496
(513) 769-8500

E-mail: info@gmpopcorn.com
Web Page: gmpopcorn.com



Replacing Broken Glass

Broken glass panels can be easily replaced. Gold Medal Products Co. does not ship glass. It can be obtained from a local glass shop, always purchase tempered glass.

GLASS DIMENSIONS (Height x Width x Thickness)

Front Glass: 21.25" X 16.875" X .125"

Side Glass: 21.25" X 10.906" X .125"

1. With the machine OFF, unplug the unit and allow it to cool before attempting to replace any glass.
2. Carefully remove all loose pieces of broken glass.
3. Pull out Magnetic Clip (located above glass panel in cabinet interior) to remove (see Figure A below).
4. Slide glass panel up under top ridge, then swing the bottom of the panel out and lower it away from unit (see Figures A and B below).
5. Carefully remove the rest of the broken glass.
6. Remove all rigid glass channels from around the glass to be replaced, set channels aside for reuse.
7. Apply decals (if desired) to the new glass panel.
8. Slide rigid glass channels over the exposed edges of the new glass panel.
9. Carefully slide new glass panel up under top ridge, then lower it into the bottom channel.
10. Reinstall magnetic clip above the new panel in cabinet interior.

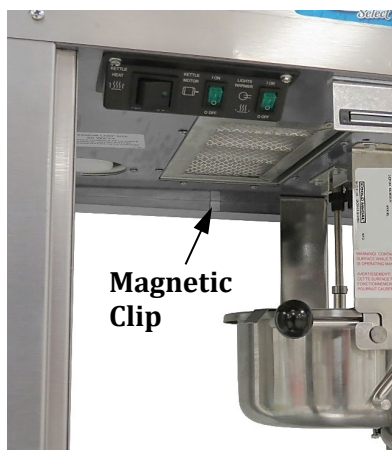

Figure A - Remove magnetic clip located above glass panel.



Figure B - Slide glass panel up under top ridge.



Figure C - Swing bottom of glass panel out, then lower it away from unit.

General images shown for glass installation reference only.

6 oz. Kettle Assembly (49434EXN) – Agitator Assembly View

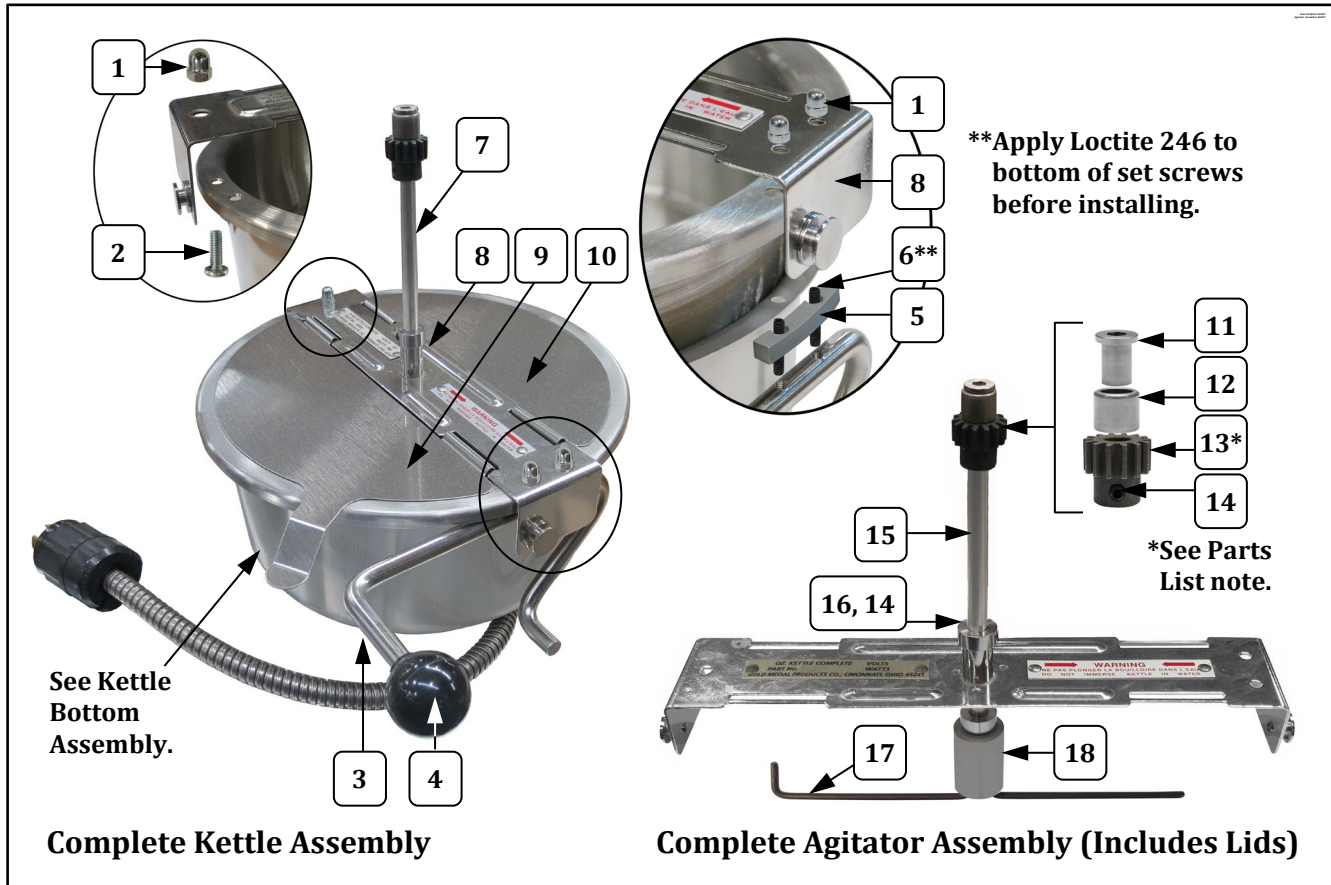

Item	Part Description	Part Number
		49434EXN
1	ACORN NUT	47702
2	8-32 X 1/2 PHIL PAN M/S	47141
3	DUMP HANDLE RH	49314
4	DUMP HANDLE KNOB	47110
5	SPACER (For Dump Handle)	49362
6	8-32 X 1" SET SCREW	77933
7	LID & AGITATOR ASSY (Complete Assembly)	49435EXN
8	KETTLE CROSSBAR ASSEMBLY	49471EXN
9	FRONT LID W/FORMED LIFTER	49017
10	REAR KETTLE LID	49016
11	AGITATOR BEARING HUB	43434
12	NEEDLE BEARING	47106
13*	SPUR GEAR KIT (Includes 2 gears with set screws. Always replace Agitator Spur Gear and Kettle Drive Motor Gear as a set.)	47059K
14	SET SCREW #10-32 X 3/16	41742
15	6 OZ. AGITATOR SHAFT	69710
16	SET COLLAR 5/16 ID 5/8 OD	46649
17	6 OZ. STIR ROD	69714
18	AGITATOR WEIGHT	69715



6 oz. Kettle Assembly (49434EXN) – Kettle Bottom Assembly

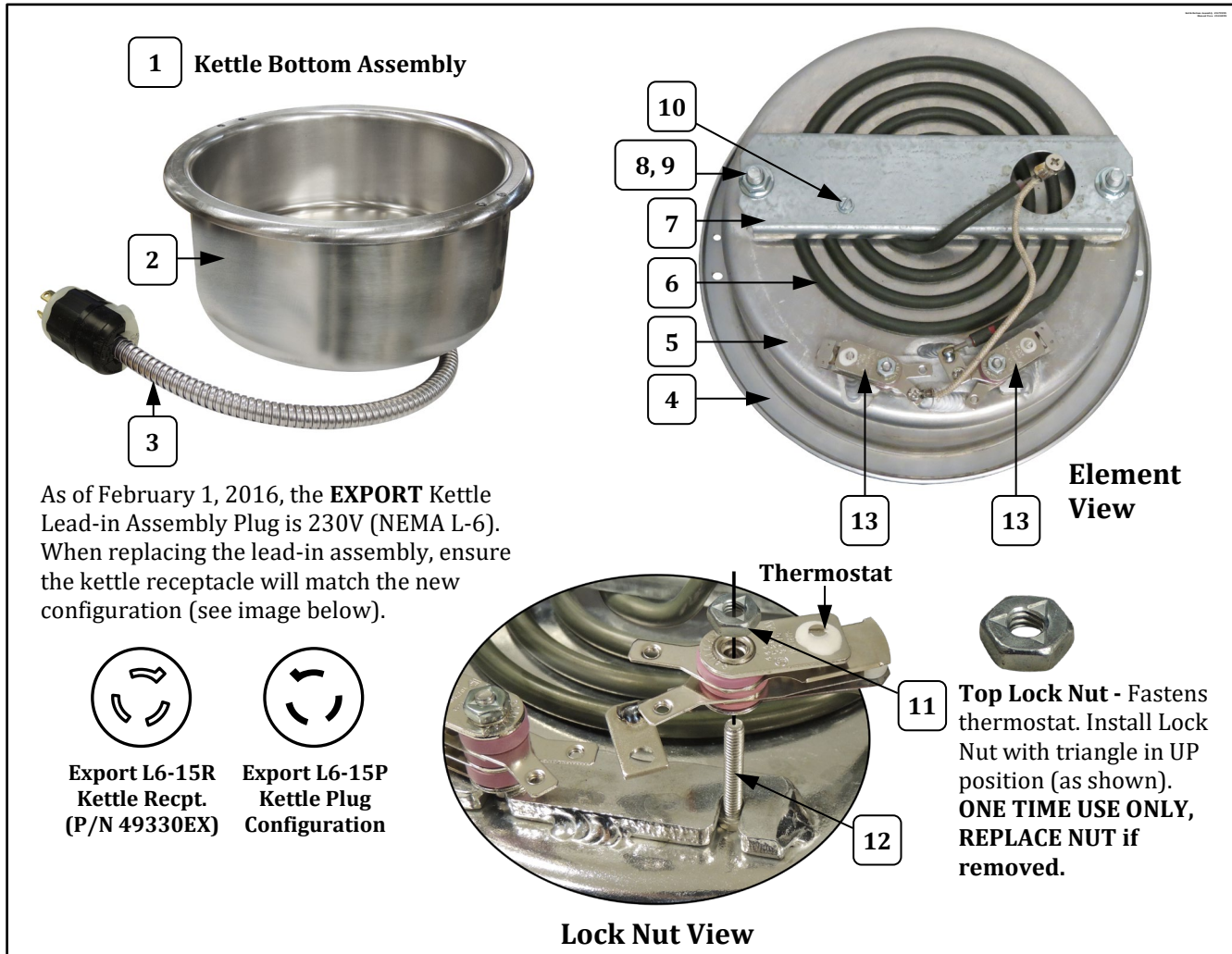

Item	Part Description	Part Number
		49434EXN
1	8 OZ. KETTLE BOTTOM ASSEMBLY (Complete Assembly - includes parts listed below)	49433EXN
2	KETTLE SHELL	49431
3	KETTLE LEAD ASSEMBLY	49490
4	6 OZ. KETTLE GASKET	49368
5	6 OZ. CLAD KETTLE	49596
6	850W TUBULAR ELEMENT	46652EX
7	ELEMENT CLAMP	49532
8	5/16-18 SERRATED LOCK NUT	49317
9	5/16-18 X 3/4 SQUARE HEAD BOLT	49446
10	8-32 x 5/16 SLOTTED HEX (fastens ground)	49594
11	8-32 TOP LOCK NUT (always replace if removed)	67943
12	8-32 x 1 SS HEX SC (holds Thermostat)	49076
13	450°F THERMOSTAT (includes two 6-32 Screws)	76089



Cabinet Exterior – Front View

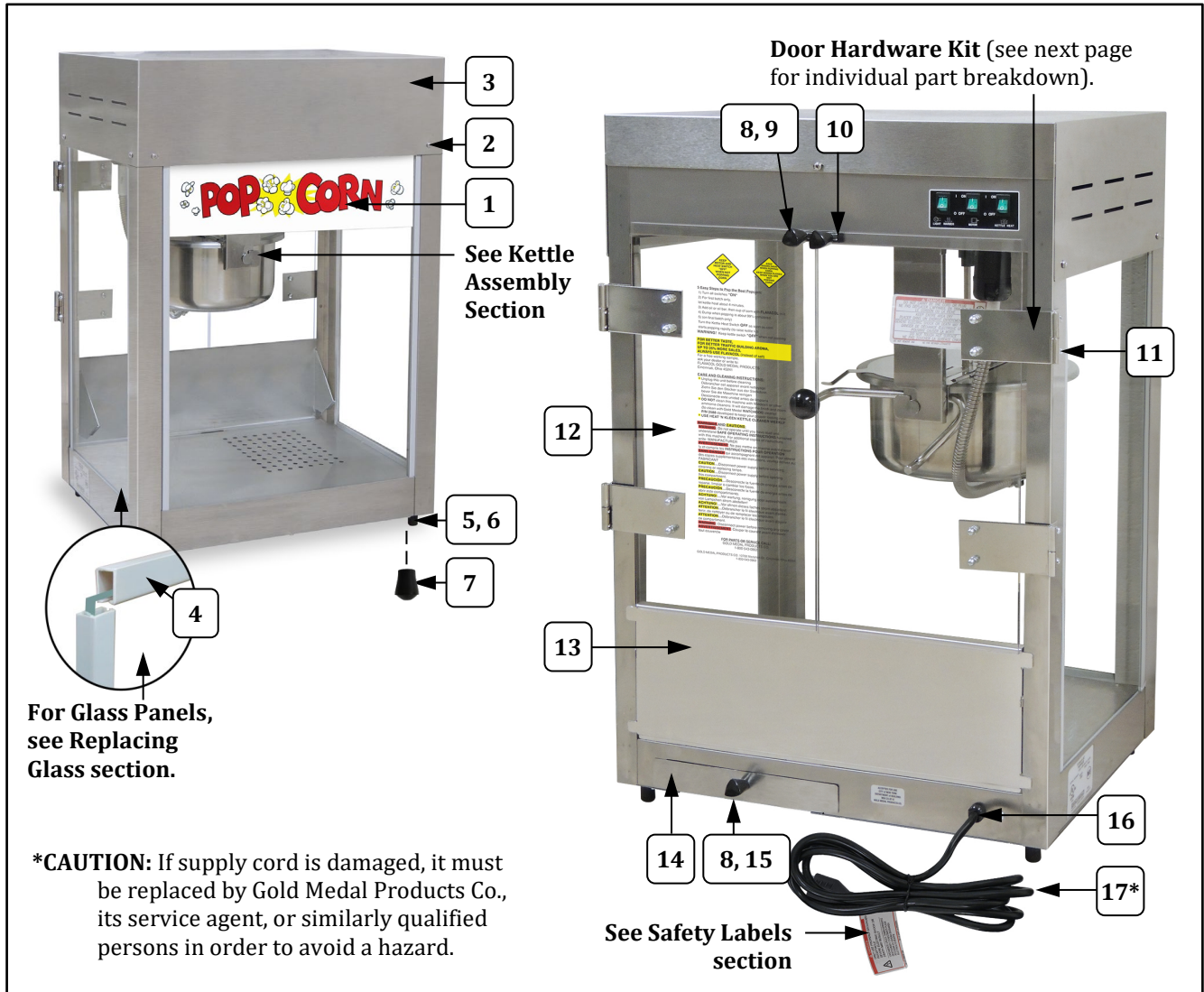

Item	Part Description	Part Number
		2551EX
1	DECAL, POPCORN	49748
2	8-32 X 3/8 SLT. HWH M/S	42044
3	DOMES	49791
4	21 5/16" GLASS CHANNEL (for side edges of glass panels)	49844
	16 1/4" GLASS CHANNEL (for top/bottom of front glass)	74172
	10 7/32" GLASS CHANNEL (for top/bottom of side glass)	49846
5	GLIDE	47328
6	10-24 X 3/4" HEX HEAD	41314
7	CRUTCH TIP BLACK 70 DURO	49123

Item	Part Description	Part Number
		2551EX
8	LID LIFT KNOB	47120
9	TEE BOLT #8-32X3/8 ZP	75267
10	MAGNETIC CATCH	47561
11	8-32 X 1/2 PHIL PAN M/S (fastens male hinges to the corner posts)	47141
12	DOOR	49816
13	DROP PANEL ASSEMBLY	49856
14	OLD MAID PAN	49100
15	8-32" X 3/8" PH PAN W/SEMS	42227
16	STRAIN RELIEF SR-6P3-4	76026
17	POWER SUPPLY CORD, EXPORT	42369



Door Hardware Kits – Individual Component Breakdown

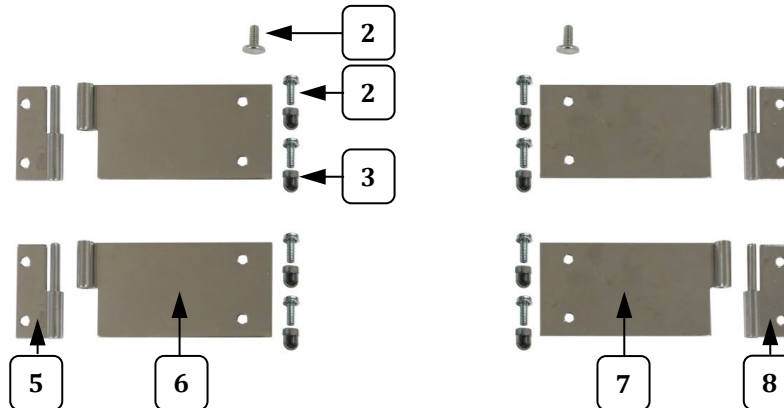

Complete Left Hand Door Hardware Kit
(P/N 47054) (contains parts shown above)

Complete Right Hand Door Hardware Kit
(P/N 47055) (contains parts shown above)

Item	Part Description	Part Number	
		47054	47055
1	DOOR KNOB	41013	41013
2	8-32 X ½ SCREWS PH PAN W/SEMS	47124	47124
3	ACORN NUT #8-32	47702	47702
4	TEE BOLT	75267	75267
5	MALE HINGE SHORT LEFT	41349	
6	FEMALE HINGE LONG LEFT	41352	
7	FEMALE HINGE LONG RIGHT		41351
8	MALE HINGE SHORT RIGHT		41350

Cabinet Interior – Controls View



Item	Part Description	Part Number
1	SWITCH LABEL	49840
2	ROCKER SWITCH DPST	42532
3	LED REPLACEMENT NO PLATE	100544
4	POWER SUPPLY 24VDC 20W	55394
5	20W POWER SUPPLY BRACKET	55414
6	.5x.5x.1 MAGNET GLASS LOCK	51113
7	REAR HANGER ARM	49009
8	FRONT HANGER ARM	49010
9*	SPUR GEAR KIT (includes 2 gears with set screws. Always replace Agitator Spur Gear <u>and</u> Kettle Drive Motor Gear as a set.)	47059K
10	SET SCREW #10-32 X 3/16	41742
11	GEAR BLOCK	67194
12	KETTLE LEAD-IN RECEPTACLE (reference Kettle Bottom Assy. for kettle plug configuration note)	49330EX

Cabinet Bottom – Corn Pan Element View

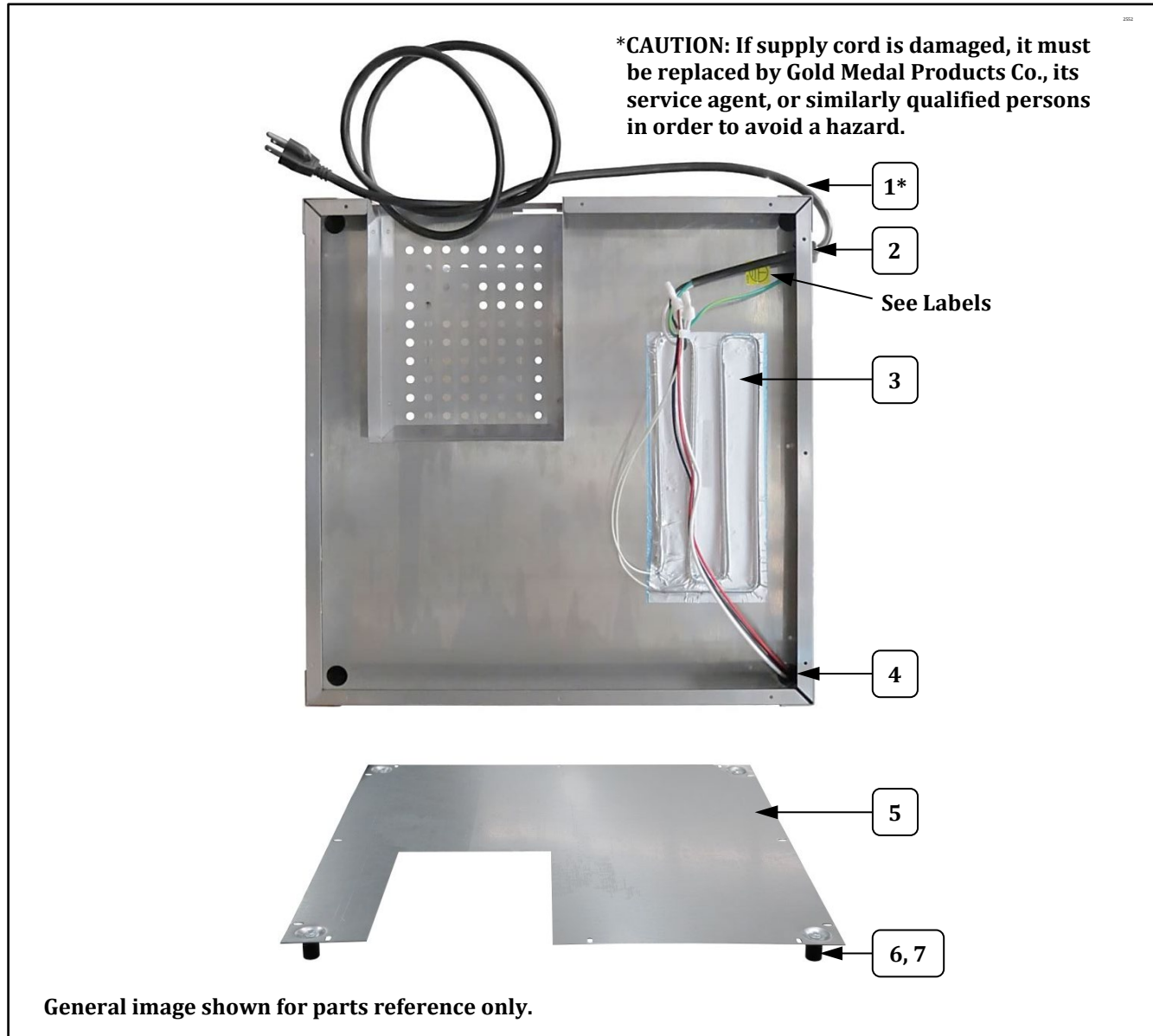

Item	Part Description	Part Number
1	POWER SUPPLY CORD, EXPORT	42369
2	STRAIN RELIEF SR-6P3-4	76026
3	230V FOIL HEATER, 20 WATT	40557EX
4	BUSHING, SNAP .500 IN	47236
5	BOTTOM COVER	49810
6	GLIDE	47328
7	10-24 X 3/4 HEX HD	41314



Safety Labels

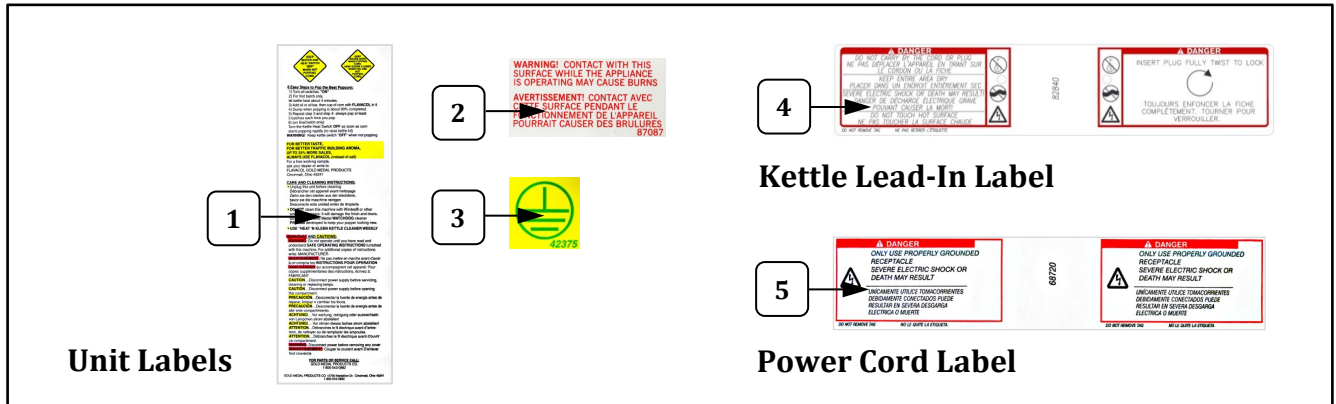

Item	Part Description	Part Number
1	UNIVERSAL POPPER DECAL	41019
2	WARNING, SURFACE CONTACT	87087
3	MAIN GROUND LABEL	42375
4	CONDUIT WARNING LABEL	82840
5	WARNING LABEL CORD	68720

Accessories

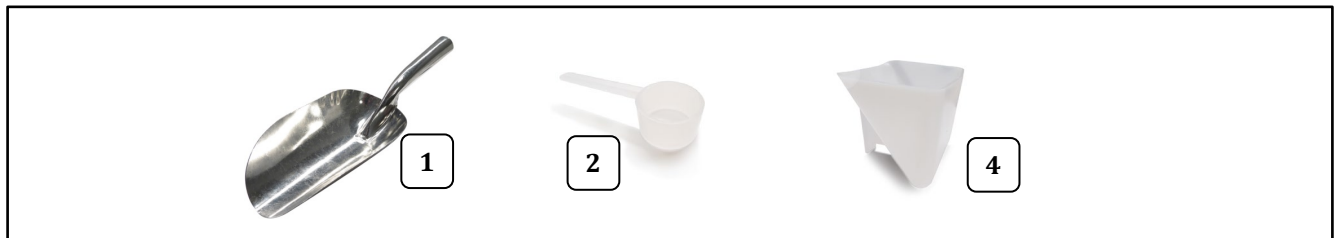

Item	Part Description	Part Number
1	STAMPED ALUMINUM SCOOP	2071
2	MEASURE 6.5CC	47678
3	MEASURE 6 OZ	49049



Wiring Diagram

Model 2551EX

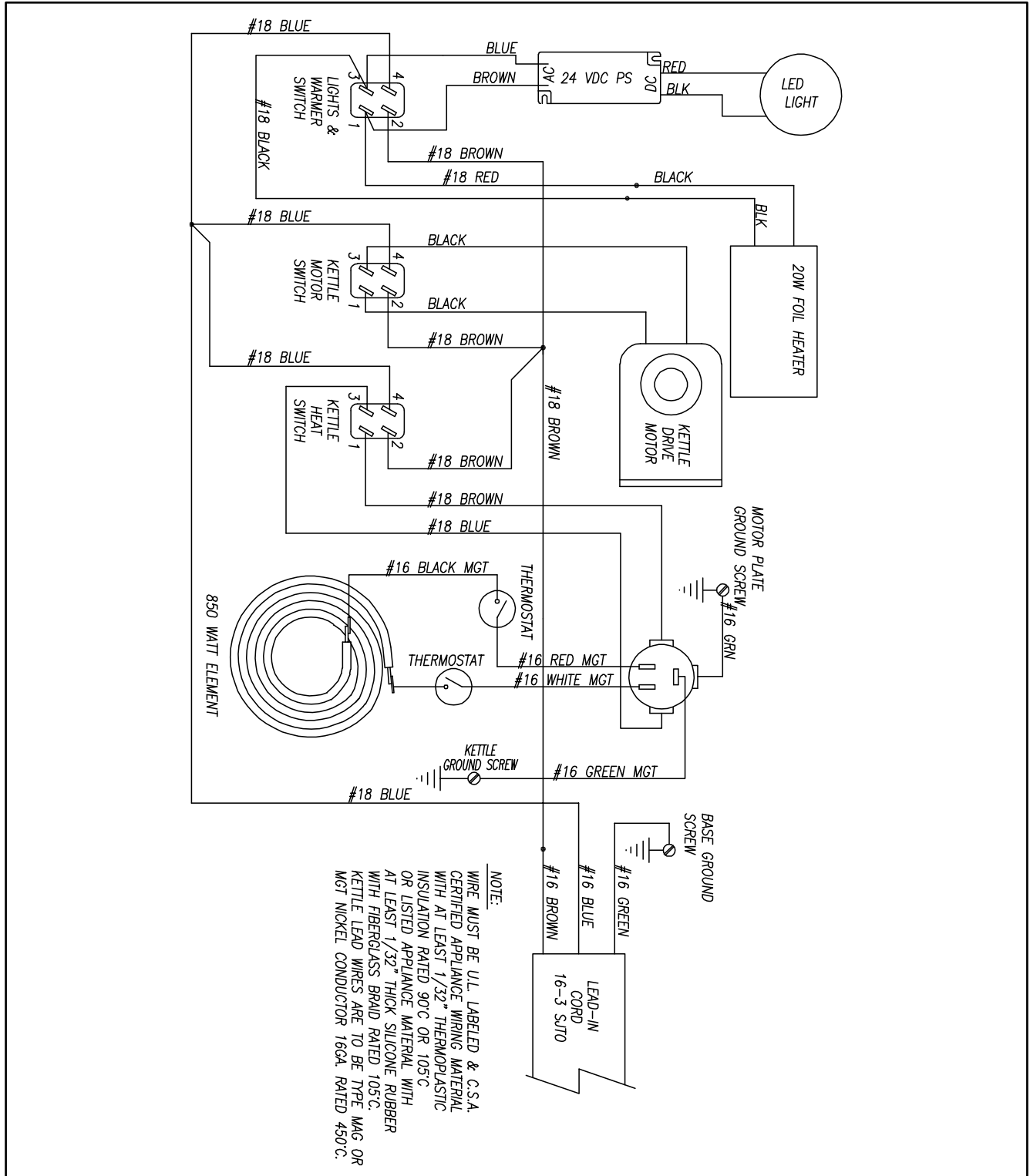



WARRANTY

Gold Medal Products Co. warrants to the original purchaser each item of its manufacture to be free of defects in workmanship and material under normal use and service. Gold Medal Products Co.'s obligation under this warranty is limited solely to repairing or replacing parts, f.o.b. Cincinnati, Ohio, which in its judgment are defective in workmanship or material and which are returned, freight prepaid, to its Cincinnati, Ohio factory or other designated point. Except for "Perishable Parts" on specific machines, the above warranty applies for a period of two (2) years from the date of original sale to the original purchaser of equipment when recommended operating instructions and maintenance procedures have been followed. These are packed with the machine. Parts warranty is two (2) years, labor is six (6) months.

THIS WARRANTY IS IN LIEU OF ALL OTHER WARRANTIES EXPRESSED OR IMPLIED, AND OF ALL OTHER OBLIGATIONS OR LIABILITIES ON OUR PART, INCLUDING THE IMPLIED WARRANTY OF MERCHANTABILITY. THERE ARE NO WARRANTIES WHICH EXTEND BEYOND THE DESCRIPTION ON THE FACE HEREOF. In no event shall Gold Medal Products Co. be liable for special, incidental or consequential damages. No claim under this warranty will be honored if the equipment covered has been misused, neglected, damaged in transit, or has been tampered with or changed in any way. No claim under this warranty shall be honored in the event that components in the unit at the time of the claim were not supplied or approved by Gold Medal Products Co. This warranty is effective only when electrical items have been properly attached to city utility lines only at proper voltages. This warranty is not transferable without the written consent of Gold Medal Products Co.

The term "Original Purchaser" as used in this warranty shall be deemed to mean that person, firm, association, or corporation who was billed by the GOLD MEDAL PRODUCTS CO., or their authorized distributor for the equipment.

THIS WARRANTY HAS NO EFFECT AND IS VOID UNLESS THE ORIGINAL PURCHASER FIRST CALLS GOLD MEDAL PRODUCTS CO. AT 1-800-543-0862 TO DISCUSS WITH OUR SERVICE REPRESENTATIVE THE EQUIPMENT PROBLEM, AND, IF NECESSARY, FOR INSTRUCTIONS CONCERNING THE REPAIR OR REPLACEMENT OF PARTS.

NOTE: This equipment is manufactured and sold for commercial use only.



GOLD MEDAL PRODUCTS CO.

10700 Medallion Drive, Cincinnati, Ohio 45241-4807 USA

gmpopcorn.com

Phone: (800) 543-0862 Fax: (800) 542-1496
(513) 769-7676 (513) 769-8500